

This slinging support for wire feeder is designed to work with torch cable supports and guarantees user safety. It is designed to fit with all industry wire feeders.

ADVANTAGES

- ✓ **ERGONOMIC,**
the welder's job is made easier
- ✓ **PRACTICAL,**
the work area is optimised.
- ✓ **SAFE,**
the hook is electrically insulated.
- ✓ **UNIVERSAL,**
all wire feeders fit.
- ✓ **STURDY,**
It can take loads up to 50 kg.



MULTI POSITIONS

Welding is facilitated thanks to the many possible positions.

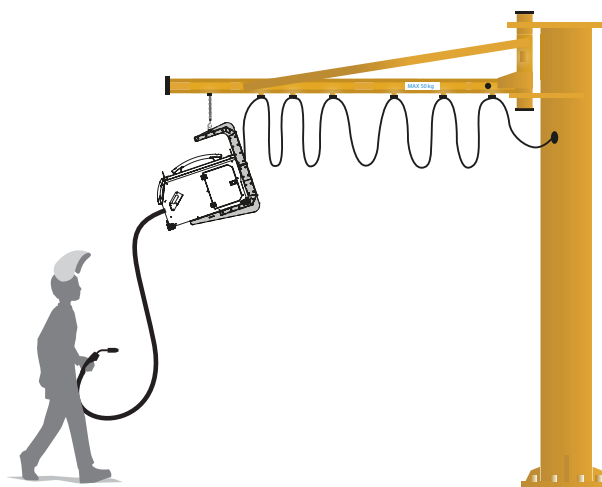
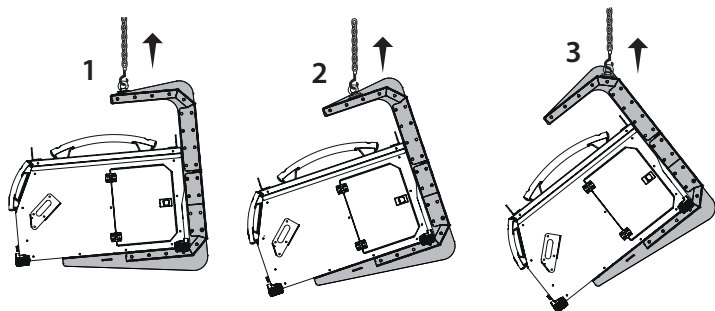

COMPATIBILITY

Fits all the following wire feeders straight away :

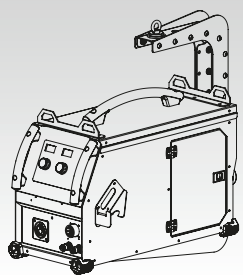

EXAFEED / GENFEED

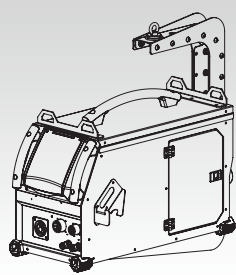

NEOFEED / PULSFEED

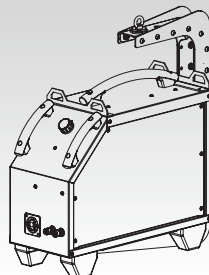

WS-4R / WS-4L

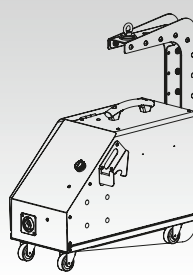

TF-4R

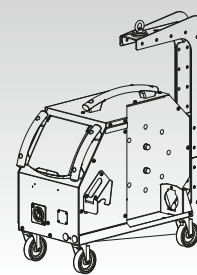

WF 35 / WF 50