

550 DaN

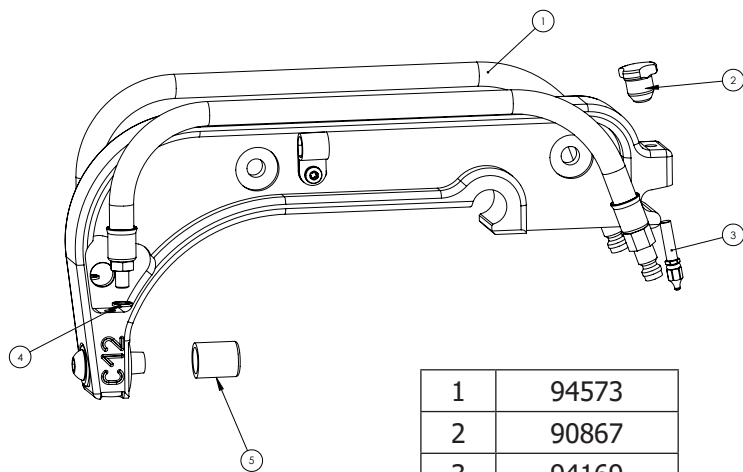

1	94573
2	90867
3	94169
4	71385
5	77027

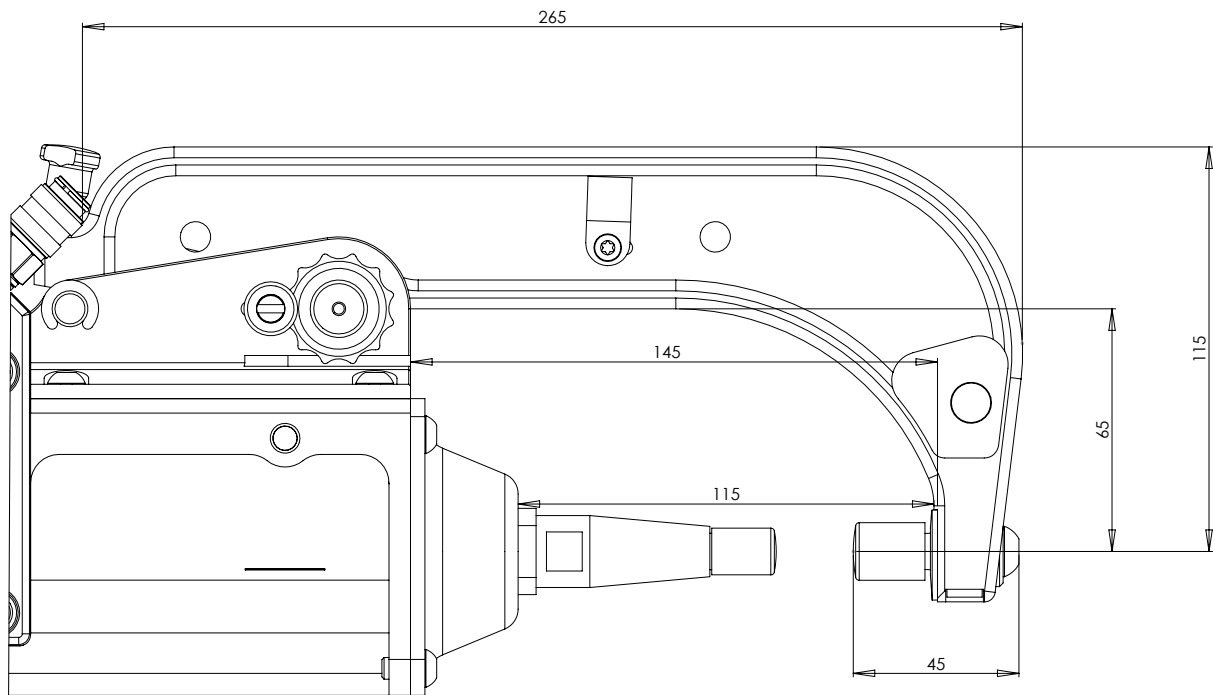

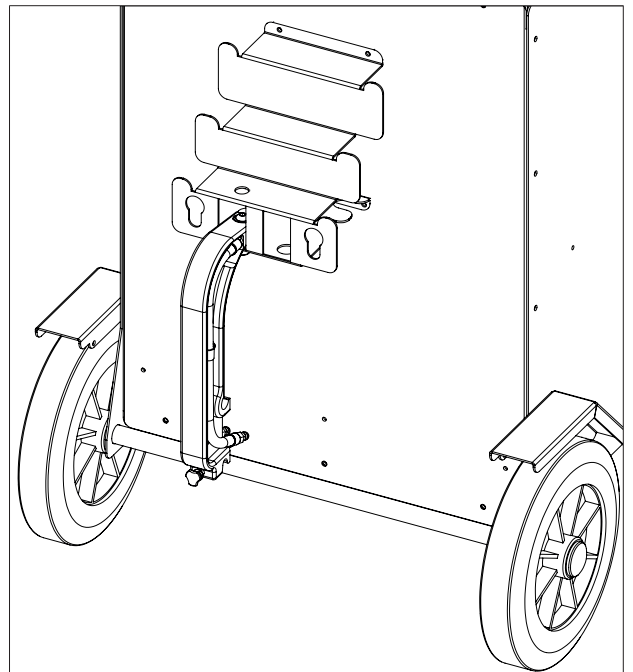
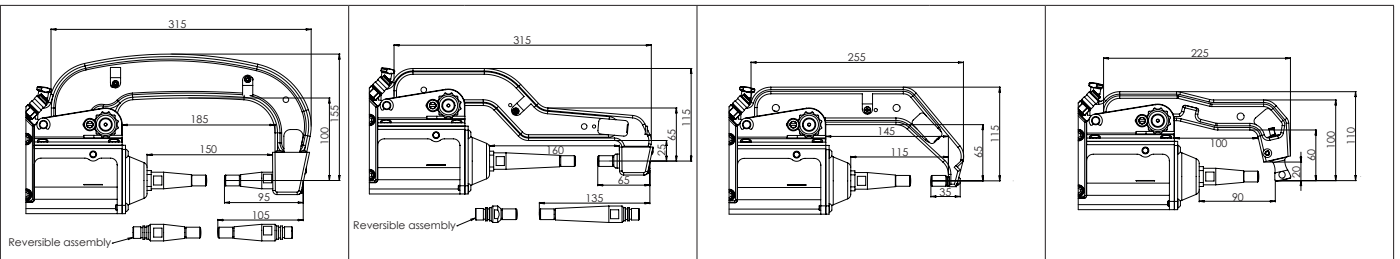

**C1 - 021402**  
8 bar / 550 daN

**C2 - 022386**  
8 bar / 550 daN

**C5 - 022393**  
8 bar / 550 daN

**C6 - 022409**  
8 bar / 300 daN

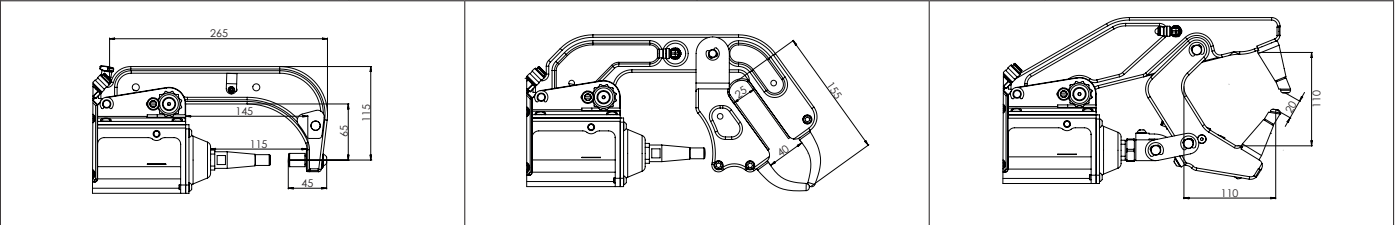

**C12 - 022997**  
8 bar / 550 daN

**C10 - 051638**  
4 bar / 150 daN

**C11 - 053649**  
8 bar / 550 daN

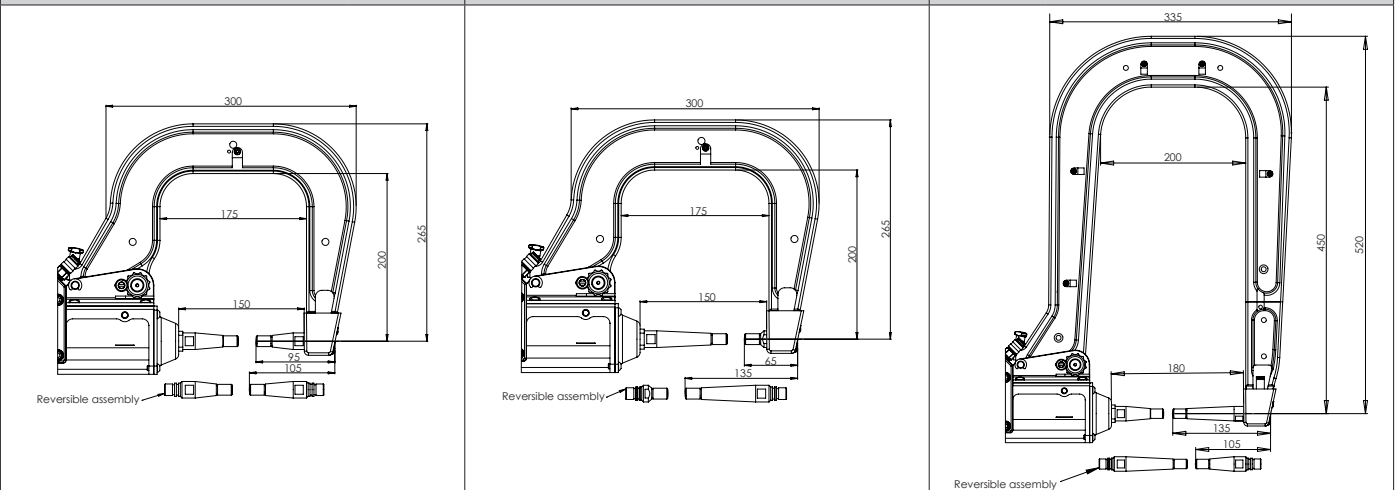

**C3 - 021419**  
8 bar / 550 daN

**C8 - 021440**  
8 bar / 550 daN

**C4 - 021426**  
8 bar / 550 daN

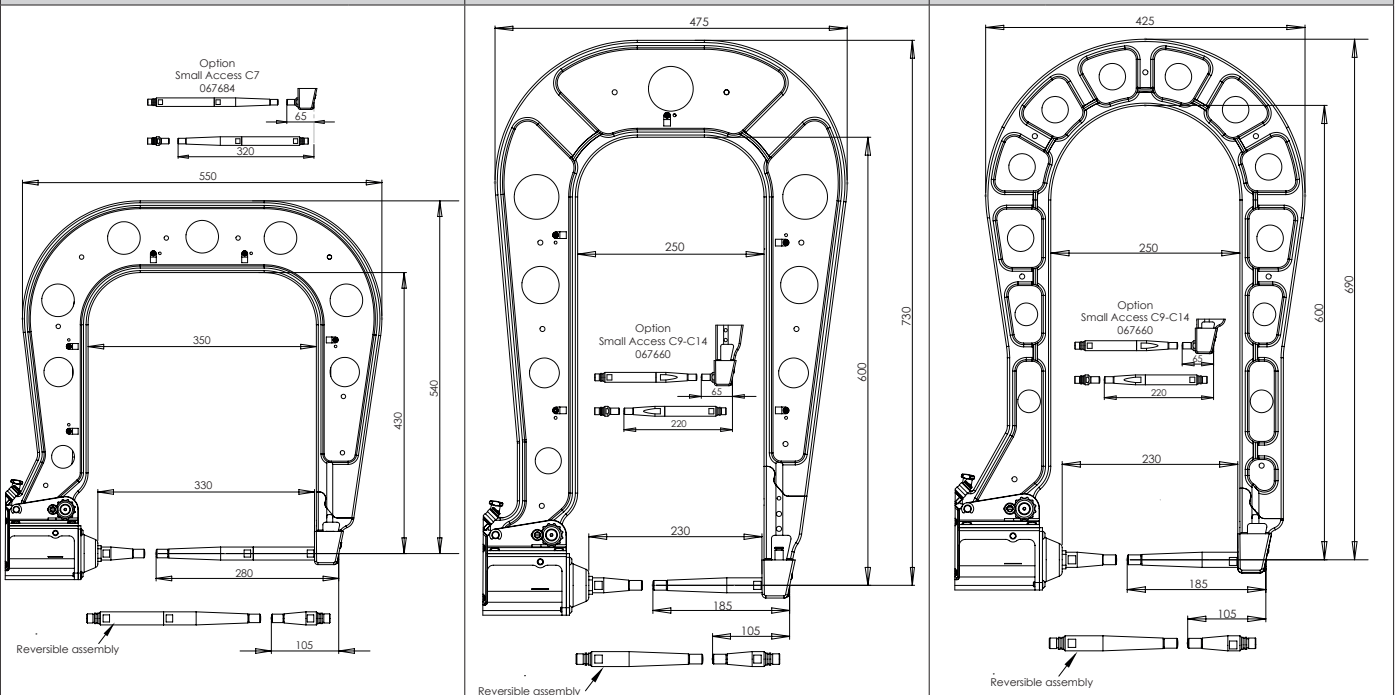

**C7 - 021433**  
8 bar / 550 daN

**C9 - 020078**  
8 bar / 550 daN

**C14 - 023543**  
8 bar / 400 daN